

POWER

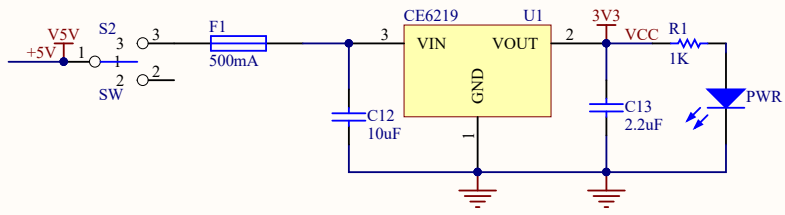

LED

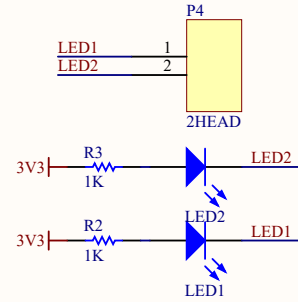

USB

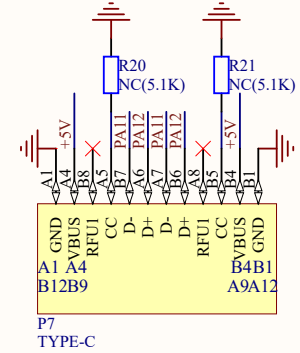

MCU

CH32V203F_MINI

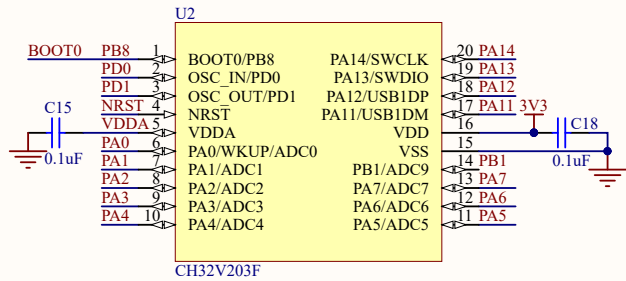

XTAL

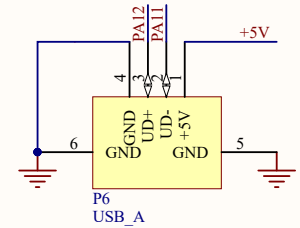
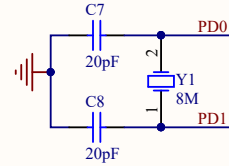

PIN

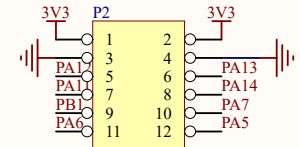
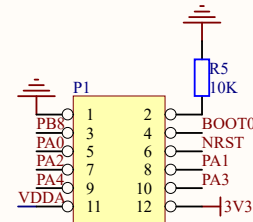

RST

