

POWER

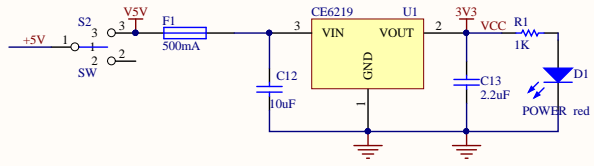

LED

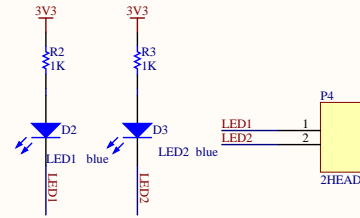

USB

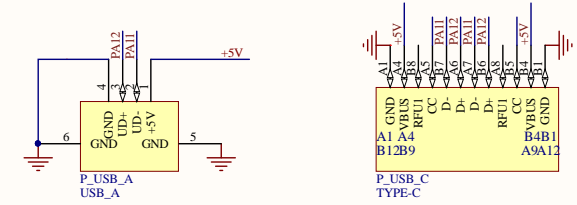

MCU

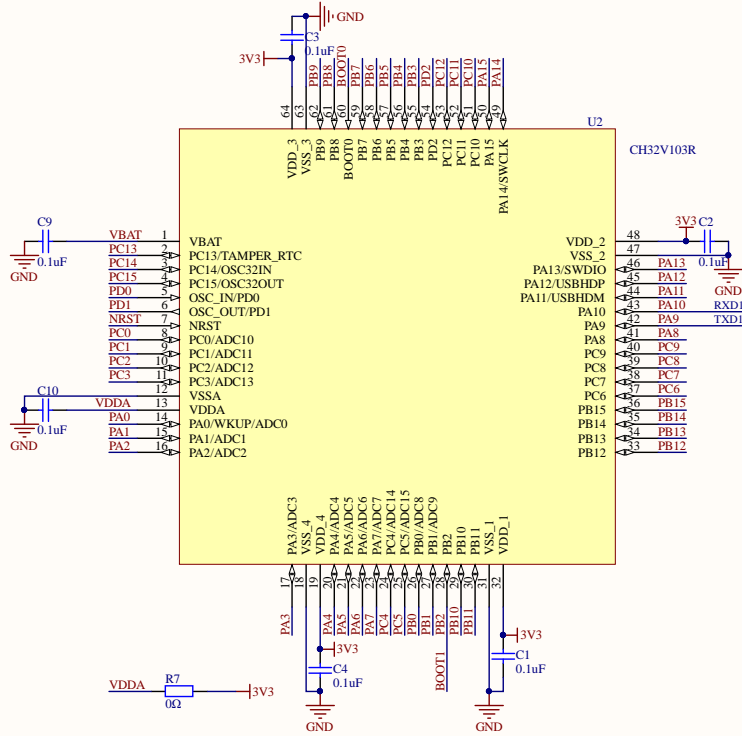

XTAL

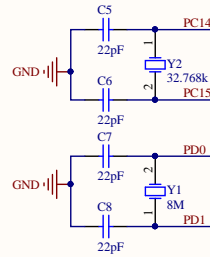

PIN

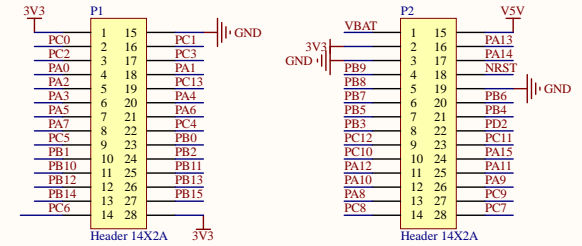

BOOT

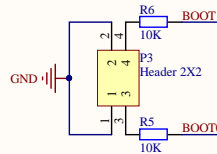

RST

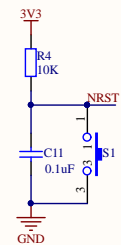

Link

